

Stone planter 80x65x40

by Stefano Giovannoni & Elisa Gargan

Stones outdoor furniture collection, designed by Stefano Giovannoni, convinces with its organic shapes. As its name suggests it appears to be found in nature itself, creating synergism between the natural and the artificial landscape. Stones can fit perfectly into any environment, transmitting its own particular elegance, thanks to its material, as well as its original shape.



Info

Description

Pot made of polyethylene resin by rotational moulding. 100% Recyclable. Item suitable for indoor and outdoor use. Available in different finishes.

Weight: 8 Kg

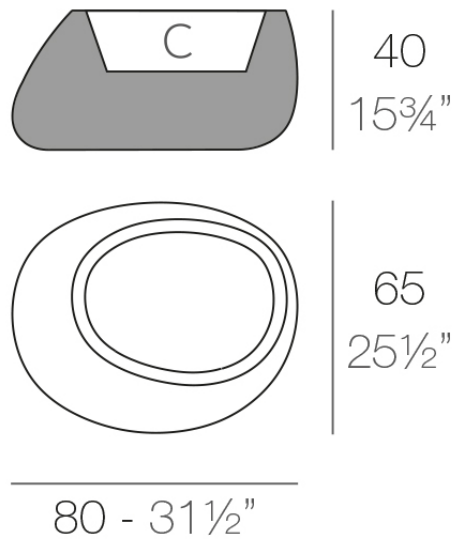

STONE Macetero 40
STONE Planter 40

C = 32 L
C = 8 1/2 gal

Ambients

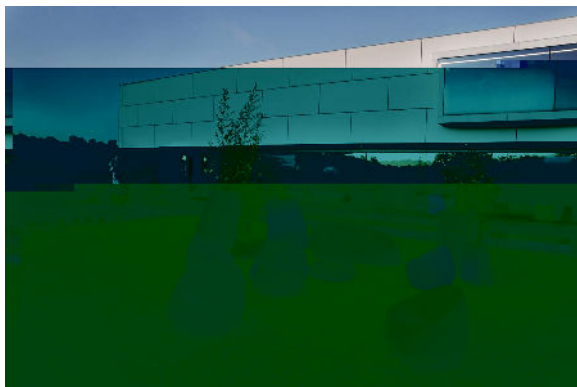

Stone planter 60x46x70

by Stefano Giovannoni & Elisa Gargan

Stones outdoor furniture collection, designed by Stefano Giovannoni, convinces with its organic shapes. As its name suggests it appears to be found in nature itself, creating synergism between the natural and the artificial landscape. Stones can fit perfectly into any environment, transmitting its own particular elegance, thanks to its material, as well as its original shape.



Info

Description

Pot made of polyethylene resin by rotational moulding. 100% Recyclable. Item suitable for indoor and outdoor use. Available in different finishes.

Weight: 8 Kg

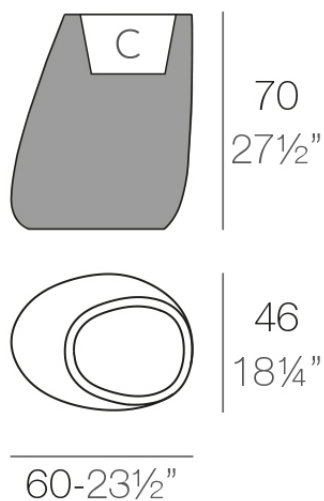

STONE Macetero 70

STONE Planter 70

C = 20 L 9 x 28 cm

C = 5 1/2 gal 45 x 104 cm

Ambients



Stone coffee table

by Stefano Giovannoni & Elisa Gargan

Stones outdoor furniture collection, designed by Stefano Giovannoni, convinces with its organic shapes. As its name suggests it appears to be found in nature itself, creating synergism between the natural and the artificial landscape. Stones can fit perfectly into any environment, transmitting its own particular elegance, thanks to its material, as well as its original shape.



Info

Description

Made of polyethylene resin by rotational moulding. 100% Recyclable. Item suitable for indoor and outdoor use. Available in different finishes.

Weight: 7 Kg

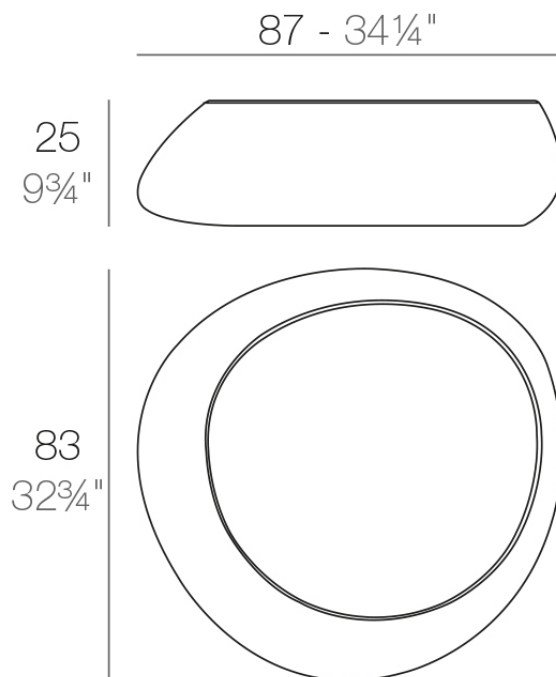

STONE Mesa Baja
STONE Low Table

Ambients



Stone planter 105x84x120

by Stefano Giovannoni & Elisa Gargan

Stones outdoor furniture collection, designed by Stefano Giovannoni, convinces with its organic shapes. As its name suggests it appears to be found in nature itself, creating synergism between the natural and the artificial landscape. Stones can fit perfectly into any environment, transmitting its own particular elegance, thanks to its material, as well as its original shape.



Info

Description

Pot made of polyethylene resin by rotational moulding. 100% Recyclable. Item suitable for indoor and outdoor use. Available in different finishes.

Weight: 25 Kg

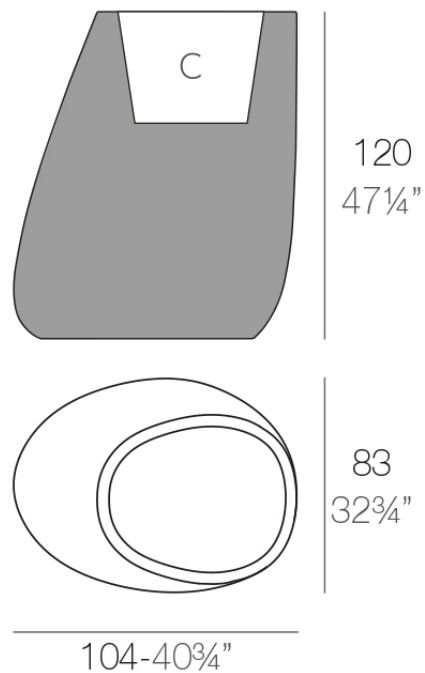

STONE Macetero 120 C = 105 L x 46 cm
STONE Planter 120 C = 27 1/2 gal x 18"

Ambients



Stone planter 86x64x100

by Stefano Giovannoni & Elisa Gargan

Stones outdoor furniture collection, designed by Stefano Giovannoni, convinces with its organic shapes. As its name suggests it appears to be found in nature itself, creating synergism between the natural and the artificial landscape. Stones can fit perfectly into any environment, transmitting its own particular elegance, thanks to its material, as well as its original shape.



Info

Description

Pot made of polyethylene resin by rotational moulding. 100% Recyclable. Item suitable for indoor and outdoor use. Available in different finishes.

Weight: 16 Kg

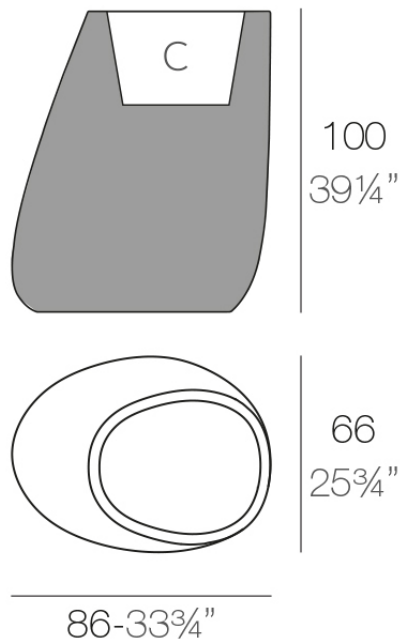

STONE Macetero 100 C = 52 L (14 x 39 cm)
STONE Planter 100 C = 13 1/2 gal (51 x 39 cm)

Ambients



Stone lounge chair

by Stefano Giovannoni & Elisa Gargan

Stones outdoor furniture collection, designed by Stefano Giovannoni, convinces with its organic shapes. As its name suggests it appears to be found in nature itself, creating synergism between the natural and the artificial landscape. Stones can fit perfectly into any environment, transmitting its own particular elegance, thanks to its material, as well as its original shape.



Info

Description

Made of polyethylene resin by rotational moulding. 100% Recyclable. Item suitable for indoor and outdoor use. Available in different finishes.

Weight: 13 Kg

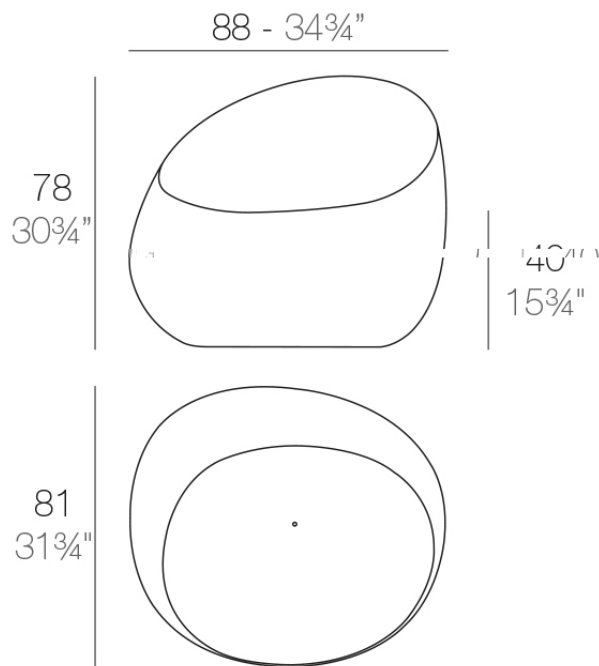

STONE Butaca
STONE Lounge Chair

Ambients

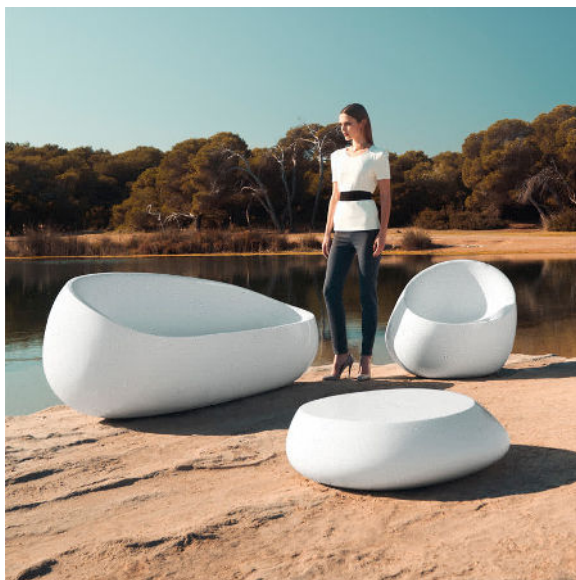

Stone sofa

by Stefano Giovannoni & Elisa Gargan

Stones outdoor furniture collection, designed by Stefano Giovannoni, convinces with its organic shapes. As its name suggests it appears to be found in nature itself, creating synergism between the natural and the artificial landscape. Stones can fit perfectly into any environment, transmitting its own particular elegance, thanks to its material, as well as its original shape.



Info

Description

Made of polyethylene resin by rotational moulding. 100% Recyclable. Item suitable for indoor and outdoor use. Available in different finishes.

Weight: 40 Kg

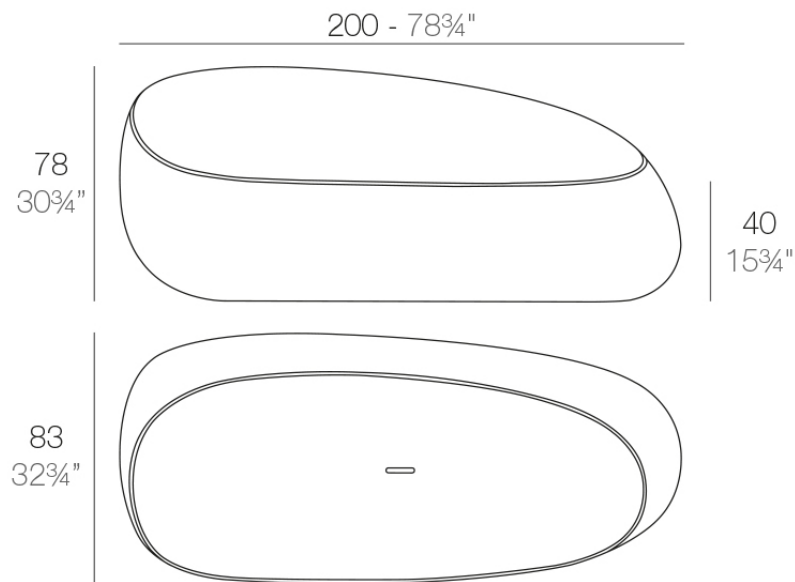

STONE Sofá
STONE Sofa

Ambients

